

Data Sheet

Screwless Terminal Block

Pitch: 7,50 mm

Serie: A11Q021

Customer Information for special Item

EDCON Customer : 0

Customer Version No. : 0

EDCON-COMPONENTS

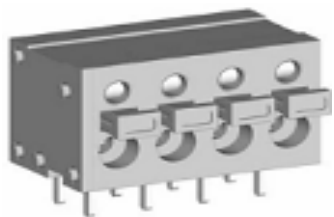

Technical Discription

Drawing (Dimension in mm)

Electrical

Standard
 Rated voltage
 Rated current
 Wire range
 Withstanding voltage

UL	IEC
300V	130V, 250V, 450V
8A	10A
26-16 AWG	1.5mm ²
AC2000V/1Min	

Mechanical

Wire strip length
 Operating temperature

8 ~ 9mm
 -40°C ~ +105°C

Dimensions

Pitch
 Poles

7.50mm
 1P - xxP

Material

Housing
 Pin header
 Wire guard

PA66 (UL94V-0)
 Brass, Tin plated
 Stainless steel

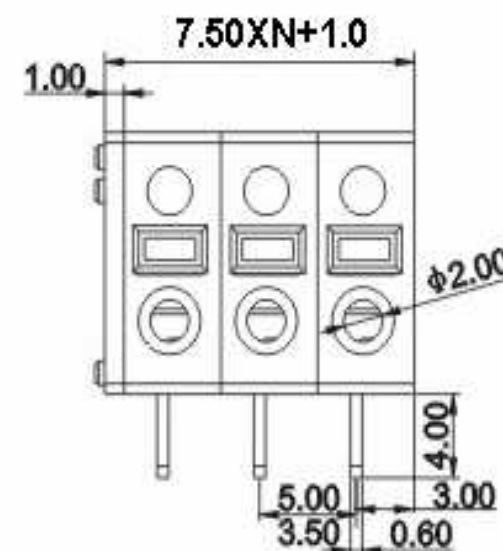
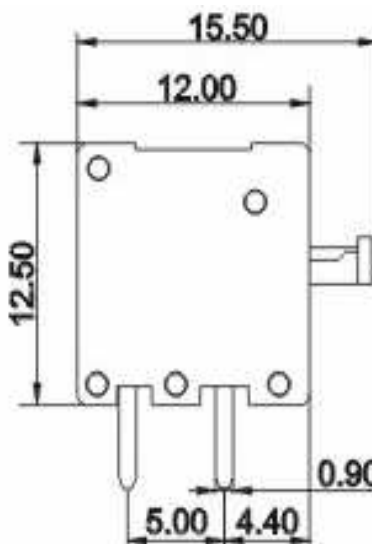

Screwless Terminal Block

Part No.: **A11Q021**

Customer:

DRW:	Jason	CHKD	Wilson	MATL:	Wilson	TOLERANCE	Mason	DATE	06.02.2014
APPD:	Schumi			FINISH	Jamy		Sheet No.	1 from 4	

EDCON-COMPONENTS

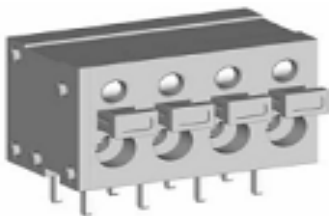

PCB Layout (Dimension in mm)

Dimensions (mm)

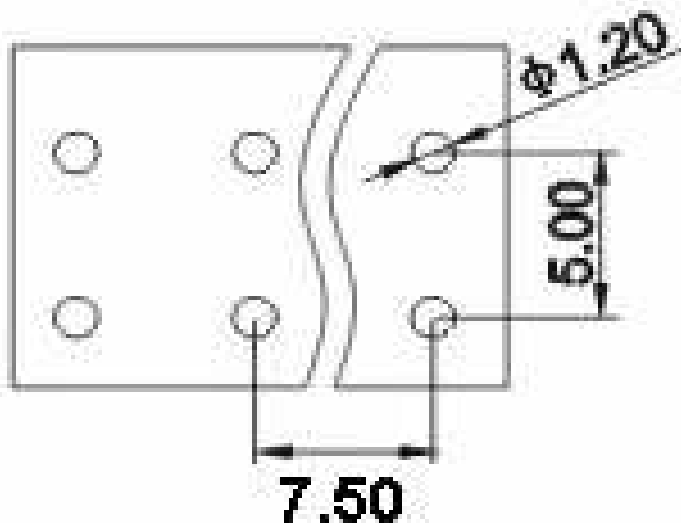

No. of Pos.	A	Tol. P	B	Tol. P
02	16,00	± 0,35	7,50	± 0,35
03	23,50	± 0,35	15,00	± 0,35
04	31,00	± 0,35	22,50	± 0,35
05	38,50	± 0,35	30,00	± 0,35
06	46,00	± 0,35	37,50	± 0,35
07	53,50	± 0,35	45,00	± 0,35
08	61,00	± 0,35	52,50	± 0,35
09	68,50	± 0,35	60,00	± 0,35
10	76,00	± 0,35	67,50	± 0,35
11	83,50	± 0,35	75,00	± 0,35
12	91,00	± 0,35	82,50	± 0,35

Screwless Terminal Block
 Part No.: **A11Q021**

DRW:	Jason	CHKD	Wilson	MATL:	Wilson	TOLERANCE	Mason	DATE	06.02.2014	Customer:
APPD:	Schumi			FINISH	Jamy		Sheet No.	2 from 4		

EDCON-COMPONENTS

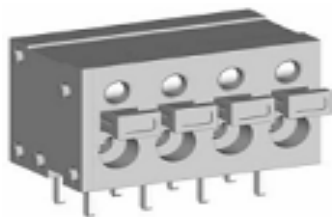

Ordering Informations

Serie	No. of Pos.	Body Color	Approval	Approval Code	ROHS	Packing	EDCON Cust. No.	Customer Version		
A11Q021	02	GY	N	N	R	B				

Pitch
7,50

02= Number of Pos. Standard 2~12 Pos.	GY= Gray (Standard) GN= Green OR= Orange BK= Black	N= No Approval 1= Approval for Material 2= Approval for Terminal Block	N= NON Approval A= UL /UR Approval Please consult EDCON for available B= VDE Approval Please consult EDCON for available C= TÜV Approval Please consult EDCON for available	R= ROHS Conform N= NON ROHS Conform	B= Standard Package I= Individual Package	xxxxxx= Customer Number	xxx= Customer Version ??(Printing)
---	---	---	--	--	--	--------------------------------	---

Screwless Terminal Block	
Part No.:	A11Q021
Customer:	

DRW:	Jason	CHKD	Wilson	MATL:	Wilson	TOLERANCE	Mason	DATE	06.02.2014
APPD:	Schumi			FINISH	Jamy			Sheet No.	3 from 4

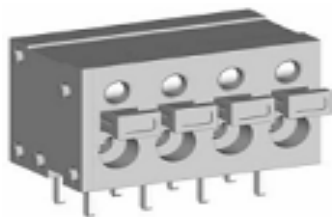

Soldering Profile Curve

Classification Reflow Profile (JEDEC J-STD-020C)

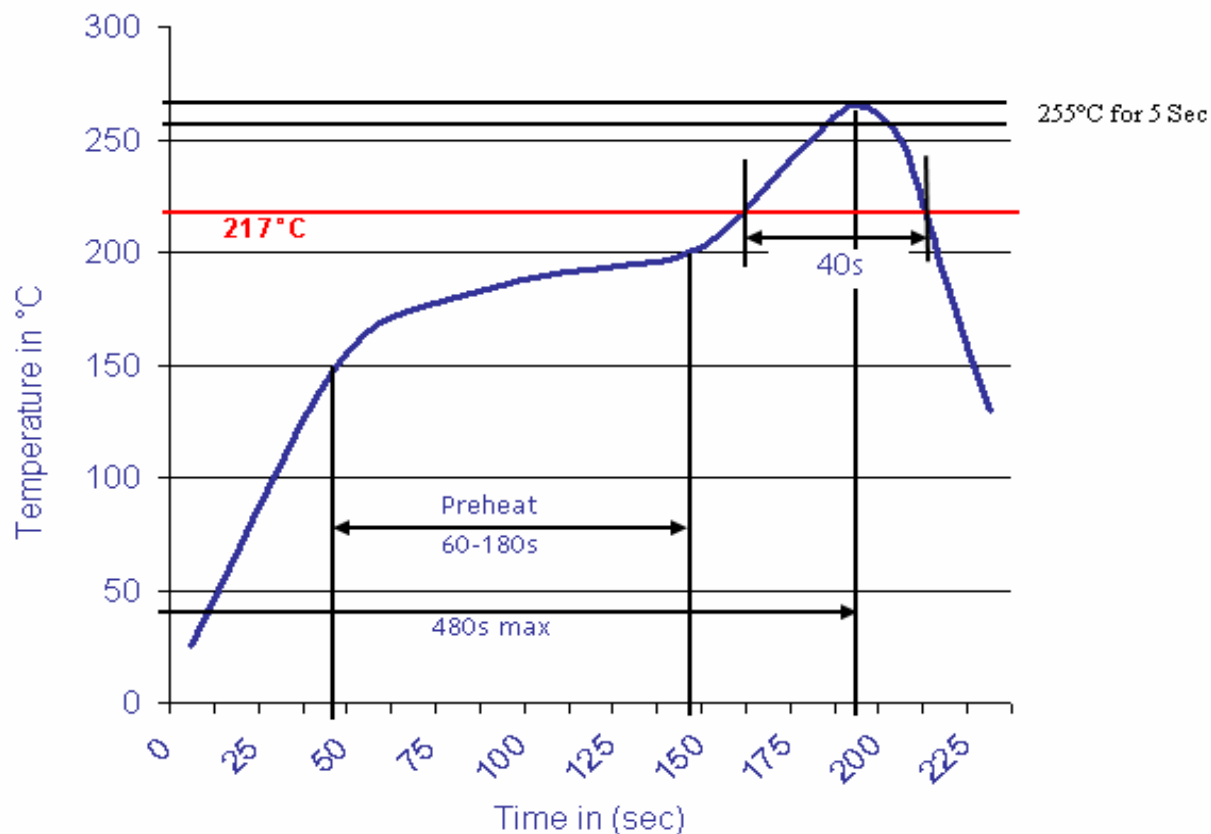

Screwless Terminal Block

Part No.: **A11Q021**

Customer:

DRW:	Jason	CHKD	Wilson	MATL:	Wilson	TOLERANCE	Mason	DATE	06.02.2014
APPD:	Schumi			FINISH	Jamy		Sheet No.	4 from 4	

