

Data Sheet

THT Screwless Terminal Block Pitch 3,50mm

Pitch: 3,50 mm

Serie: A11G012

Customer Information for special Item

EDCON Customer : xxxxxx

Customer Version No. : xx

EDCON-COMPONENTS

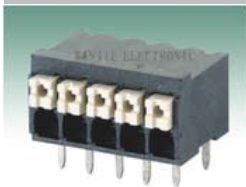

Technical Description

Electrical:

Rated voltage:
Rated current:
Withstanding Voltage: AC/1min:
Operating Temperature:

UL	IEC	VDE
300V	160V	
10A	13,5A	
2,0KV	2,0KV	

-40°C ~ +105°C

Mechanical:

Strip length: mm
Wire range: Solid wire: AWG
Wire range: Stranded wire:AWG

9 ~ 10	9 ~ 10	
16-24	16-24	
16-24	16-24	

Material:

Housing Terminal Body: Thermoplastik UL94V-0
Housing Left-side: Thermoplastik UL94V-0
Housing Right side: Thermoplastik UL94V-0
Lever: Thermoplastik UL94V-0 White RAL9003
Terminal: Copper Matte Tin plated over Nickel
Spring Clamp: Stainless steel

Drawing (Dimension in mm)

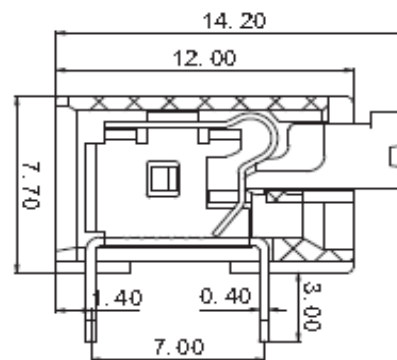
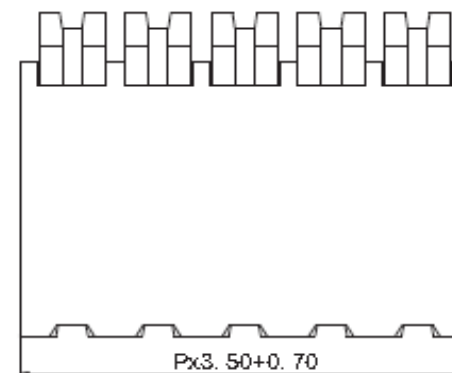
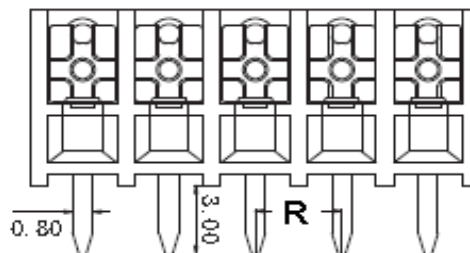

Item No.		
1		
2		
3		
4		
5		
6		
7		
8		
9		

Tolerances unless otherwise specified (mm)				
x	x.X	x.XX	x.XXX	Angle
±	±	±	±	±3°
DRW:	Jason	CHKD	Wilson	MATL:
APPD:	Schumi			FINISH

THT Screwless Terminal Block Pitch 3,50mm	
Part No.:	A11G012
Customer:	

DRW:	Jason	CHKD	Wilson	MATL:	Wilson	TOLERANCE	Mason	DATE	17.03.2018
APPD:	Schumi			FINISH	Jamy		Sheet No.		1 from 4

EDCON-COMPONENTS

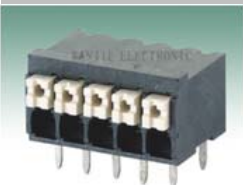

PCB Layout Dimension (mm)

TOP-VIEW

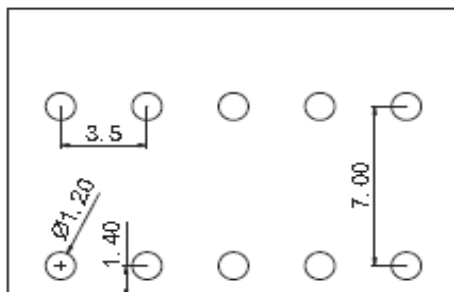

Dimensions (mm)

P	Tol. P	R	Tol. P	No. of Pos.
7,70	± 0,35	3,50	± 0,35	02
11,20	± 0,35	7,00	± 0,35	03
14,70	± 0,35	10,50	± 0,35	04
18,20	± 0,35	14,00	± 0,35	05
21,70	± 0,35	17,50	± 0,35	06
25,20	± 0,35	21,00	± 0,35	07
28,70	± 0,35	24,50	± 0,35	08
32,20	± 0,35	28,00	± 0,35	09
35,70	± 0,35	31,50	± 0,35	10
39,20	± 0,35	35,00	± 0,35	11
42,70	± 0,35	38,50	± 0,35	12
46,20	± 0,35	42,00	± 0,35	13
49,70	± 0,35	45,50	± 0,35	14
53,20	± 0,35	49,00	± 0,35	15
56,70	± 0,35	52,50	± 0,35	16
60,20	± 0,35	56,00	± 0,35	17
63,70	± 0,35	59,50	± 0,35	18
67,20	± 0,35	63,00	± 0,35	19
70,70	± 0,35	66,50	± 0,35	20
74,20	± 0,35	70,00	± 0,35	21
77,70	± 0,35	73,50	± 0,35	22
81,20	± 0,35	77,00	± 0,35	23
84,70	± 0,35	80,50	± 0,35	24

**THT Screwless Terminal Block
Pitch 3,50mm**

Part No.: **A11G012**

Customer:

DRW:	Jason	CHKD	Wilson	MATL:	Wilson	TOLERANCE	Mason	DATE	17.03.2018
APPD:	Schumi			FINISH	Jamy		Sheet No.		2 from 4

EDCON-COMPONENTS

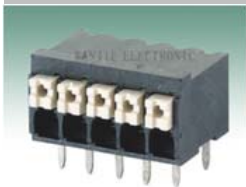

Ordering Informations

Serie	No. of Pos.	Body Color	Srew Type	Approval Code	ROHS	Packing	EDCON Cust. No.	Customer Version		
A11G012	02	BK	C	N	R	B	xxxxxx	xx		

Pitch
3,50

02= Number of Pos.		C= Screwless Type	N= NON Approval	R= ROHS Conform	B= Standard Package Box/ Polybag	xxxxxx= Customer Number	xx= Customer Version (Printing) ??
Standard 2 ~ 24Pos.			1= UL-Approval for Body Material	N= NON ROHS Conform	I= Individual Package		
			A= UL /UR Approval Please consult EDCON for available				
			B= VDE Approval Please consult EDCON for available				
		BK= Black	C= TÜV Approval Please consult EDCON for available				

THT Screwless Terminal Block Pitch 3,50mm
Part No.: A11G012
Customer:

DRW:	Jason	CHKD	Wilson	MATL:	Wilson	TOLERANCE	Mason	DATE	17.03.2018
APPD:	Schumi			FINISH	Jamy		Sheet No.		3 from 4

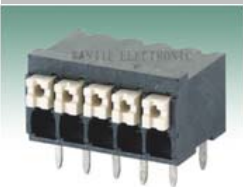

Soldering Profile Curve

Classification Reflow Profile (JEDEC J-STD-020C)

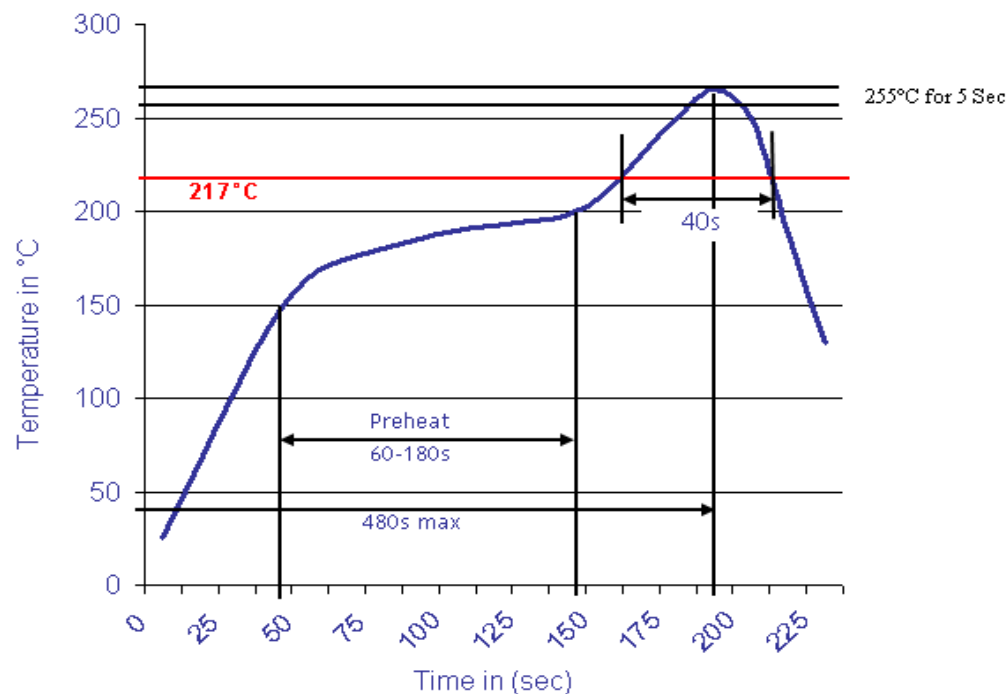

**THT Screwless Terminal Block
Pitch 3,50mm**

Part No.: **A11G012**

Customer:

DRW:	Jason	CHKD	Wilson	MATL:	Wilson	TOLERANCE	Mason	DATE	17.03.2018
APPD:	Schumi			FINISH	Jamy		Sheet No.	4 from 4	